



NEW PRODUCTS

2019

HC28



PLEGAT 伯格
Ximi Li 李希米



编号: YH25

框架结构: 框架为实木与多层板结构, 金属底架 / **饰面:** 沙发主体为软包面料或皮, 底脚为黑灰色氟碳漆 / **坐垫软包:** 坐垫为高弹海绵复合, 最上层为蓬松棉填充 / **面料:** 沙发套不可拆卸, 多种面料或牛皮可选 / **靠包:** 珍珠棉和鹅绒混合填充, 纯棉靠包内套, 外套为可拆卸的面料或牛皮套

STRUCTURE: Structure in solid wood and plywood, base in metal / **FINISHING:** Upholstered with fabric or leather, base in dark grey epoxy paint / **SEAT CUSHION:** Seat cushion in high density foam polyurethane and dacron / **COVERING:** Non-removable covering in fabric or leather / **CUSHIONS:** Polyester padding and goose down with cotton pre-covering, removable covering in fabric or leather

沙发 SOFA

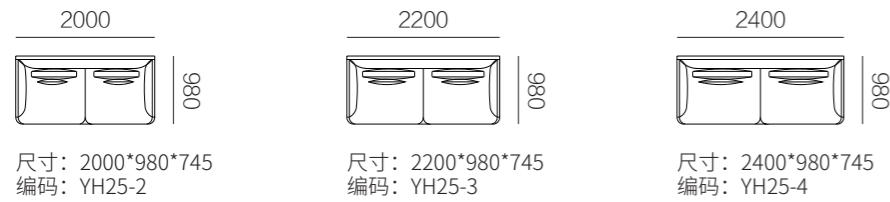

单扶 LEFT/RIGHT ONE-ARMED SOFA

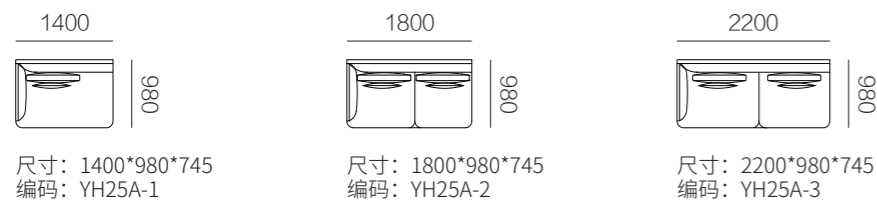

单背 SOFA WITHOUT ARM



墩 OTTOMAN



转角 LEFT/RIGHT CHAISE



角位 LEFT/RIGHT CORNER SEAT

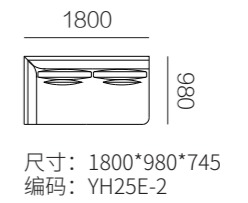

组合沙发 SECTIONAL SOFA

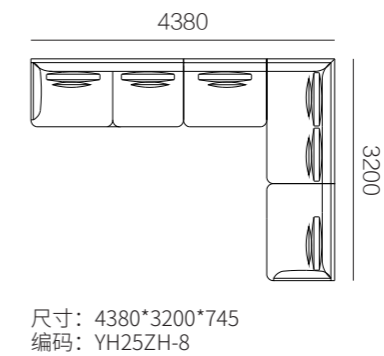
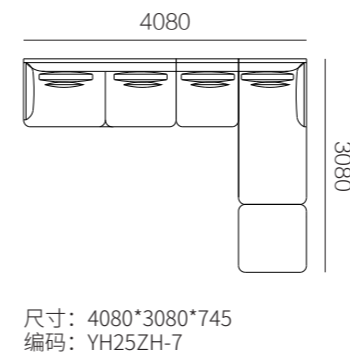
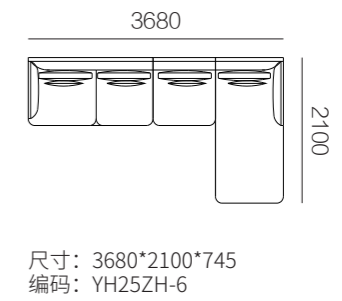
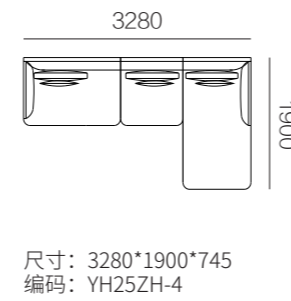
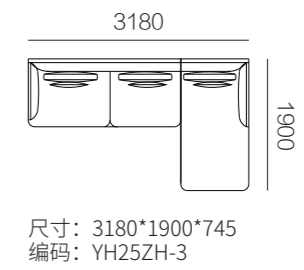
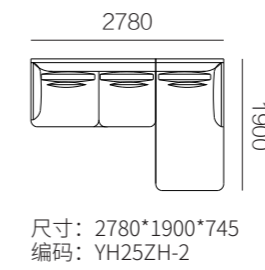
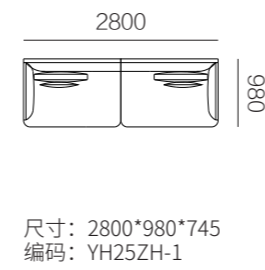



PLEGAT 伯格
Ximi Li 李希米

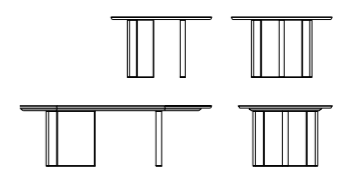

尺寸: D800*420
编号: LX02

尺寸: 1700*800*320
1400*650*320
编号: LX01

结构: 桌面为大理石或者实木及板材贴皮, 金属框架嵌入实木立柱 / **表面效果:** 桌面为中花白大理石或杭灰大理石, 或者胡桃木或染色橡木, 框架为黑灰色氟碳漆,配胡桃木或者染色橡木立柱

STRUCTURE: Top in marble or solid wood and veneer on particles board, base in metal and solid wood / **FINISHING:** Top in venato white marble or charly brown marble, walnut or stained oak, base in dark grey epoxy paint with walnut or stained oak

COVER 寰宇
Yonoh



尺寸: 760*860*885
编号: YH24

结构: 框架为实木与多层板结构, 底价为金属 / **表面效果:** 主体为软包面料或皮, 底座为黑灰色氟碳漆, 金色底脚 / **坐垫:** 坐垫为高弹海绵复合, 上层为蓬松棉填充

STRUCTURE: Structure in solid wood and plywood, base in metal / **FINISHING:** Upholstered with fabric or leather, base in dark grey epoxy paint, feet in copper plated stainless steel / **SEAT:** Seat cushion in high density foam polyurethane and dacron

HERON 海伦
Frank Chou 周宸宸



尺寸: 675*754*760
编号: B34A

结构: 框架为实木与多层板结构, 实木沙发腿 / **表面效果:** 主体为软包面料或皮, 底座为胡桃木或染色橡木 / **坐垫:** 坐垫为高弹海绵复合, 上层为蓬松棉填充

STRUCTURE: Structure in solid wood and plywood, legs in solid wood / **FINISHING:** Upholstered with fabric or leather, legs in walnut or stained oak / **SEAT:** Seat cushion in high density foam polyurethane and dacron



FOUR SEASONS 四季

L&L Studio



编号: L171

框架结构: 框架为实木与多层板结构, 木质围边带金属底架 / **饰面:** 沙发整体为软包面料或牛皮, 木质围边为胡桃木或染色橡木, 底脚为黑灰色氟碳漆 / **坐垫软包:** 坐垫为高弹海绵复合, 最上层为蓬松棉和羽绒填充 / **面料:** 沙发套可拆卸, 多种面料或牛皮可选 / **靠包:** 珍珠棉和羽绒混合填充, 纯棉靠包内套, 外套为可拆卸的面料或牛皮套

STRUCTURE: Structure in solid wood and plywood, veneered base with legs in metal / **FINISHING:** Upholstered with fabric or leather, base in walnut or stained oak, legs in dark grey epoxy paint / **SEAT CUSHION:** Seat cushion in high density foam polyurethane, dacron and feather / **COVERING:** Removable covering in fabric or leather / **CUSHIONS:** Polyester padding and feather with cotton pre-covering, removable covering in fabric or leather

沙发 SOFA

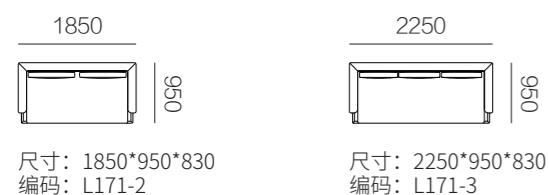

尺寸: 1850*950*830
编码: L171-2

尺寸: 2250*950*830
编码: L171-3

单扶 LEFT/RIGHT ONE-ARMED SOFA

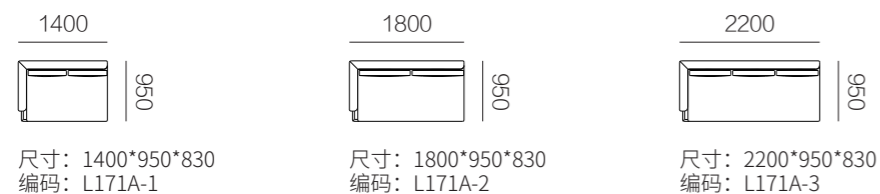

尺寸: 1400*950*830
编码: L171A-1

尺寸: 1800*950*830
编码: L171A-2

尺寸: 2200*950*830
编码: L171A-3

单背 SOFA WITHOUT ARM

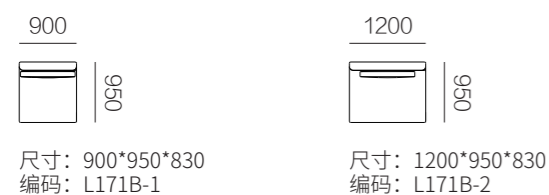

尺寸: 900*950*830
编码: L171B-1

尺寸: 1200*950*830
编码: L171B-2

转角 LEFT/RIGHT CHAISE



尺寸: 1800*950*830
编码: NO171C-1

尺寸: 2000*950*830
编码: NO171C-2

墩 OTTOMAN



尺寸: 900*990*375
编码: NO171D

角位 LEFT/RIGHT CORNER SEAT



尺寸: 950*950*830
编码: NO171E-1

尺寸: 1800*950*830
编码: NO171E-2

组合沙发 SECTIONAL SOFA

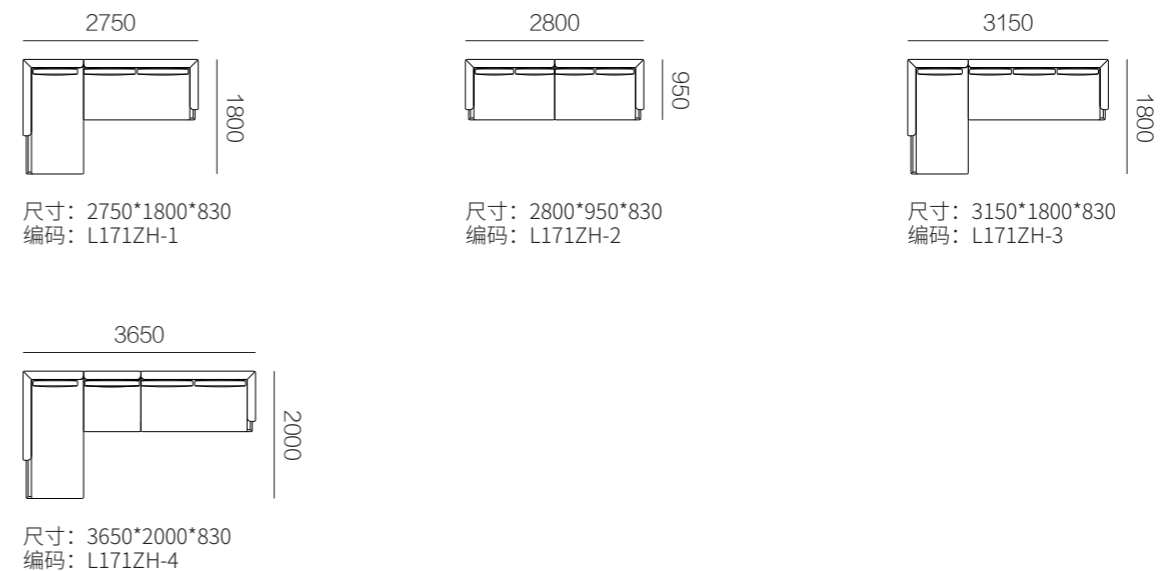

尺寸: 2750*1800*830
编码: L171ZH-1

尺寸: 2800*950*830
编码: L171ZH-2

尺寸: 3150*1800*830
编码: L171ZH-3

尺寸: 3650*2000*830
编码: L171ZH-4

VITO 维多
René Chyba

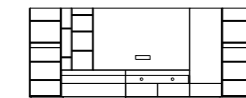

尺寸: 4200*506*1700
3600*506*1700
3000*506*1700
编号: J03

结构: 整体为实木和板材贴皮, 除了书架整体单元和最底层矮抽屉面为为烤漆密度板, 柜体右侧为镜面 / **表面效果:** 主体为胡桃或染色橡木, 书架整体单元和最底层矮抽屉面为烤漆, 且两部分的烤漆颜色可不同。柜体右侧黑色镜面单元带背光

STRUCTURE: Whole in solid wood and veneer on particles board, except shelf units and bottom drawer fronts in lacquered MDF, and right side with mirrored panel / **FINISHING:** Whole in walnut or stained oak, except whole shelf units and bottom lower drawer fronts in lacquer, and the lacquer colors for those two parts can be different. Black mirror unit on the right with strip lights

PLEGAT 伯格
Ximi Li 李希米

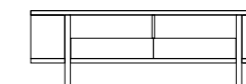

尺寸: 2300*496*550
2100*496*550
1760*496*550
编号: LX09

结构: 主体为板材贴皮, 金属框架 / **表面效果:** 整体为胡桃木或染色橡木时, 框架为黑灰氟碳漆; 整体为烟熏橡木时, 框架为仿铜拉丝做旧不锈钢配黑橡立柱

STRUCTURE: Whole piece in veneer on particles board, frame in metal or stainless steel / **FINISHING:** Whole piece in walnut or stained oak, frame in dark grey epoxy paint; Whole piece in smoked oak, frame in brushed brassy stainless steel with black oak posts



BEEN 彬彬
Yonoh



编号: YH26

框架结构: 框架为实木与多层板结构, 金属底架 / **饰面:** 主体为软包面料或皮, 底架为黑色丝光烤漆金属 / **坐垫软包:** 坐垫为高弹海绵复合, 最上层为蓬松棉和羽绒填充 / **面料:** 沙发套可拆卸, 多种面料或牛皮可选 / **靠包:** 珍珠棉和鹅绒混合填充, 纯棉靠包内套, 外套为可拆卸的面料或牛皮套

STRUCTURE: Structure in solid wood and plywood, base in metal / **FINISHING:** Upholstered with fabric or leather, base in silk black lacquered metal / **SEAT CUSHION:** Seat cushion in high density foam polyurethane, dacron and feather / **COVERING:** Removable covering in fabric or leather / **CUSHIONS:** Polyester padding and goose down with cotton precovering, removable covering in fabric or leather

沙发 SOFA

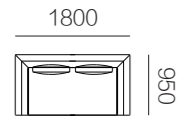

尺寸: 1800*950*650
编码: YH26-2

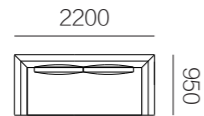

尺寸: 2200*950*650
编码: YH26-3

单扶 LEFT/RIGHT ONE-ARMED SOFA



尺寸: 950*950*650
编码: YH26A-1

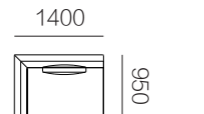

尺寸: 1400*950*650
编码: YH26A-2

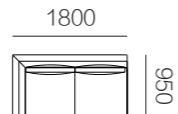

尺寸: 1800*950*650
编码: YH26 A-3

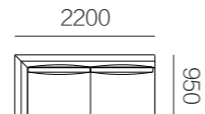

尺寸: 2200*950*650
编码: YH26A-4

单背 SOFA WITHOUT ARM

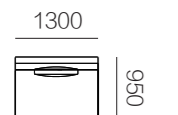

尺寸: 1300*950*650
编码: YH26B-1

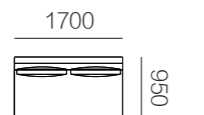

尺寸: 1700*950*650
编码: YH26B-2

转角 LEFT/RIGHT CHAISE

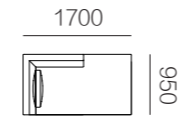

尺寸: 1700*950*650
编码: YH26C-1

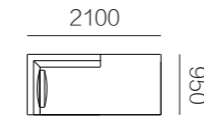

尺寸: 2100*950*650
编码: YH26C-2

墩 OTTOMAN

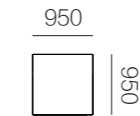

尺寸: 950*950*400
编码: YH26D

角位 LEFT/RIGHT CORNER SEAT



尺寸: 950*950*650
编码: YH26E

组合沙发 SECTIONAL SOFA

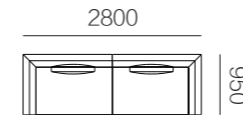

尺寸: 2800*950*650
编码: YH26ZH-1

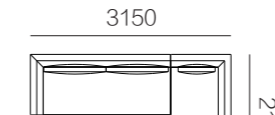

尺寸: 3150*2100*650
编码: YH26ZH-2

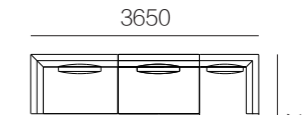

尺寸: 3650*2600*650
编码: YH26ZH-3

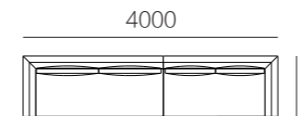

尺寸: 4000*2750*650
编码: YH26ZH-4



尺寸: 4300*2650*650
编码: YH26ZH-5

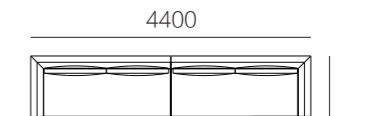

尺寸: 4400*3600*650
编码: YH26ZH-6

PIANPIAN 偏偏

Steve Leung 梁志天



编号: T33

框架结构: 框架为实木与多层板结构, 金属底座 / **饰面:** 主体为软包面料或皮, 底座为黑色丝光烤漆金属 / **坐垫软包:** 坐垫为高弹海绵复合, 最上层为蓬松棉 / **面料:** 沙发套不可拆卸, 多种面料或牛皮可选 / **靠包:** 珍珠棉和鹅绒混合填充, 纯棉靠包内套, 外套为可拆卸的面料

STRUCTURE: Structure in solid wood and plywood, base in metal / **FINISHING:** Upholstered with fabric or leather, base in silk black lacquered metal / **SEAT CUSHION:** Seat cushion in high density foam polyurethane, dacron and feather / **COVERING:** Removable covering in fabric or leather / **CUSHIONS:** Polyester padding and goose down with cotton precovering, removable covering in fabric or leather

沙发 SOFA

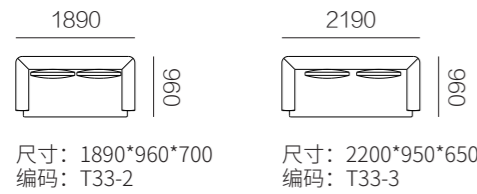

单扶 LEFT/RIGHT ONE-ARMED SOFA

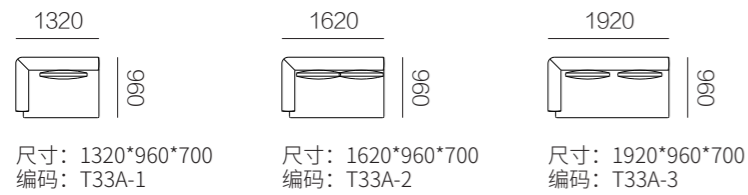

墩 OTTOMAN

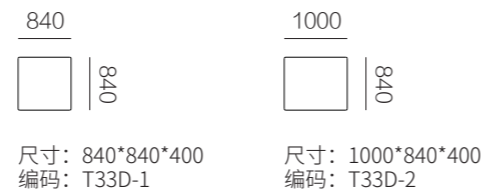

单背 SOFA WITHOUT ARM



转角 LEFT/RIGHT CHAISE

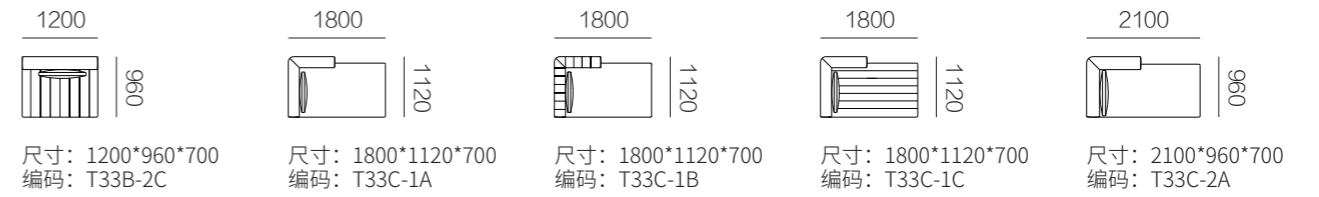

角位 LEFT/RIGHT CORNER SEAT



组合沙发 SECTIONAL SOFA

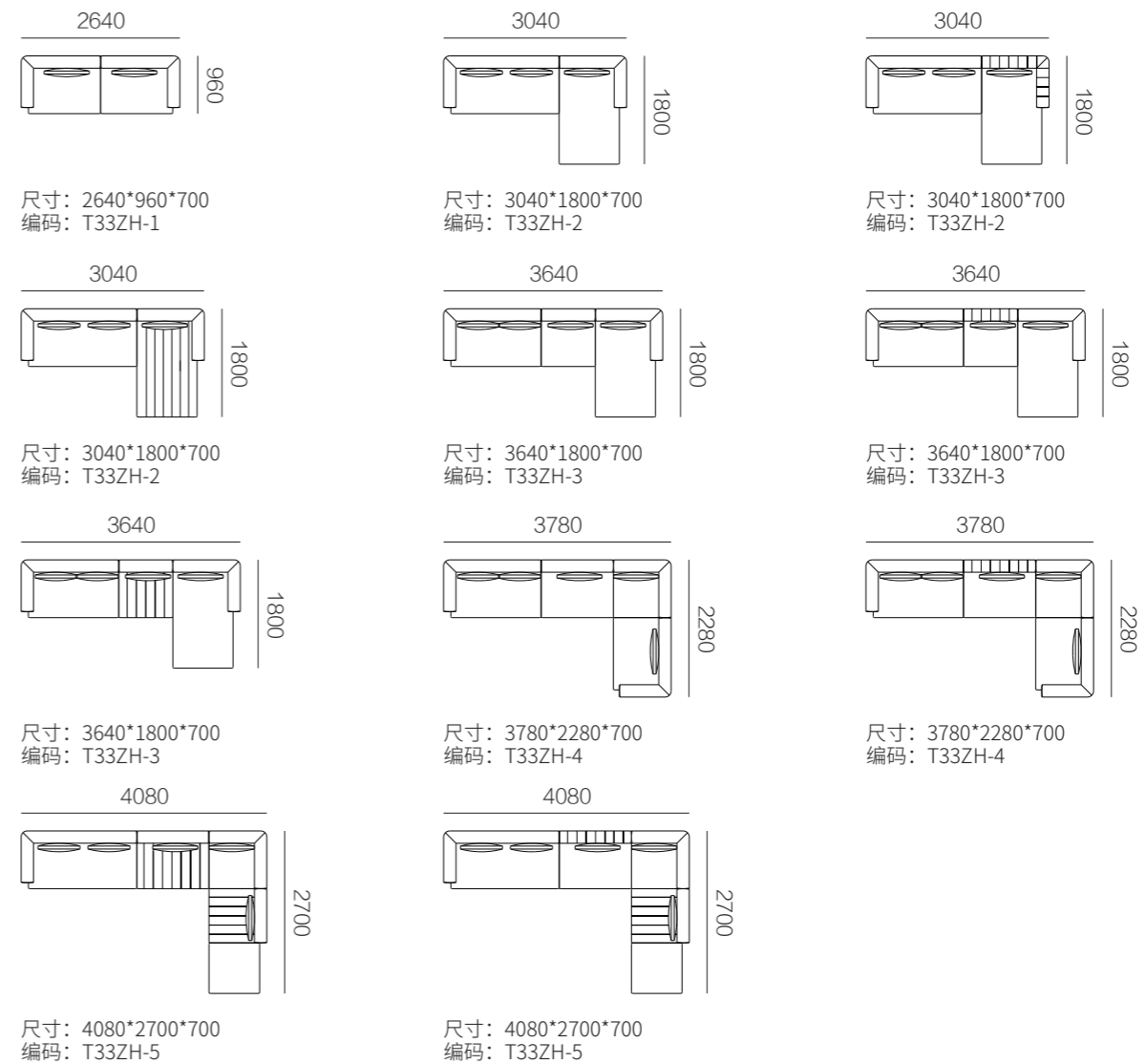



PLEGAT 伯格

Ximi Li 李希米

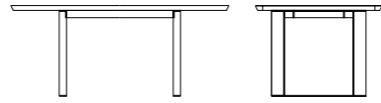

尺寸: 2800*1050*750
2400*1050*750
2200*1050*750
2000*1050*750
1800*1050*750
编号: LX05

结构: 桌面为板材贴皮, 嵌入岩板, 底座为金属框架和实木 / **表面效果:** 整体为胡桃木和染色橡木时, 框架配黑灰氟碳漆。整体为烟熏橡木时, 框架为仿铜拉丝做旧不锈钢配黑橡木立腿; 嵌入石材为黑白根或者鱼肚白

STRUCTURE: Top in stone and veneer on particles board, base and legs in solid wood and metal / **FINISHING:** When whole piece in walnut or stained oak, frame in dark grey epoxy paint. When top in smoked oak, frame in brushed brassy stainless steel with black oak; Stone available in Nero Marquina or Calacatta White

MYRA 美达

Steve Leung 梁志天

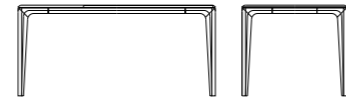
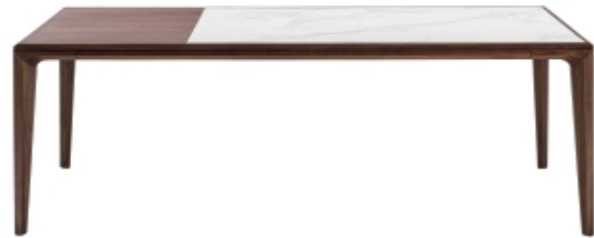

尺寸: 2250*1000*750
2050*1000*750
1850*1000*750
编号: T32

结构: 桌面为部分岩板, 部分板材贴皮, 桌腿和框架为实木 / **表面效果:** 桌腿和部分桌面为胡桃木或染色橡木, 其他部分桌面嵌入石材, 可选黑白根或鱼肚白

STRUCTURE: Top in stone and veneer on particles board, frame and legs in solid wood / **FINISHING:** Legs and part of the top in walnut or stained oak, and other part of the top in stone. Stone available in Nero Marquina or Calacatta White

PLEGAT 伯格

Ximi Li 李希米

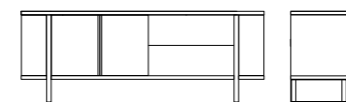

尺寸: 2284*496*800
2084*496*800
1832*496*800
1632*496*800
编号: LX010

结构: 主体为板材贴皮, 金属框架 / **表面效果:** 整体为胡桃木或染色橡木时, 框架为黑灰氟碳漆; 整体为烟熏橡木时, 框架为仿铜拉丝做旧不锈钢配黑橡木立柱

STRUCTURE: Whole piece in veneer on particles board, frame in metal or stainless steel / **FINISHING:** Whole piece in walnut or stained oak, frame in dark grey epoxy paint; Whole piece in smoked oak, frame in brushed brassy stainless steel with black oak posts

HERON 海伦

Frank Chou 周宸宸



尺寸: 500*550*820
编号: B34B

结构: 主体为多层板, 椅腿为实木 / **表面效果:** 椅腿为胡桃或染色橡木, 软包不可拆卸, 多种面料或牛皮可选

STRUCTURE: Structure in plywood, legs in solid wood / **FINISHING:** Legs in walnut or stained oak, upholstered with non-removable covering in fabric or leather

SIN 欣欣

Christophe Delcourt



尺寸: 560*536*811
编号: G75

结构: 主体为多层板, 椅腿为实木 / **表面效果:** 椅腿为胡桃或染色橡木, 软包不可拆卸, 多种面料或牛皮可选

STRUCTURE: Structure in plywood, legs in solid wood / **FINISHING:** Legs in walnut or stained oak, upholstered with non-removable covering in fabric or leather

PLEGAT 伯格

Ximi Li 李希米

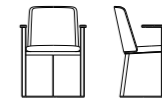

尺寸: 572*553*786
编号: LX04

结构: 主体为多层板, 椅腿为不锈钢框架搭配实木 / **表面效果:** 金属框架可选灰黑色氟碳漆或仿铜拉丝做旧不锈钢, 结合胡桃木或橡木立柱, 软包不可拆卸, 多种面料或牛皮可选

STRUCTURE: Structure in plywood, stainless steel frame with solid wood / **FINISHING:** Metal frame in dark grey epoxy paint or brushed brassy stainless steel, with walnut or stained oak posts, upholstered with non-removable covering in fabric or leather

PLEGAT 伯格

Ximi Li 李希米

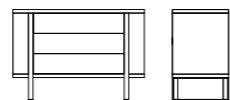

尺寸: 1160*496*800
960*496*800
编号: LX08

结构: 主体为板材贴皮, 金属框架 / **表面效果:** 整体为胡桃或染色橡木, 框架为黑灰氟碳漆

STRUCTURE: Whole piece in veneer on particles board, frame in metal / **FINISHING:** Whole piece in walnut or stained oak, frame in dark grey epoxy paint

NEW IHOME 艾玛

Francois Champsaur



尺寸: 1800*450*450
1600*450*450
编号: NO185

结构: 主体为多层板, 板材贴皮围边, 金属框架 / **表面效果:** 主体为软包面料或皮, 胡桃木或染色橡木围边, 底座黑灰氟碳漆

STRUCTURE: Structure in plywood, frame in veneer on particles board, legs in metal / **FINISHING:** Upholstered with fabric or leather, frame in walnut or stained oak, legs in dark grey epoxy paint